

SPECIFICATIONS:

CONTACT RATING: Refer to "Contact Material Options" for more info.
 ELECTRICAL LIFE: 50,000 make and break cycles at full load.
 CONTACT RESISTANCE: 10mΩ max. initial @2-4VDC
 INSULATION RESISTANCE: 1,000MΩ min.
 DIELECTRIC STRENGTH: 1,500V RMS @ sea level.
 OPERATION TEMPERATURE: -30°C to + 85°C.

MATERIALS:

CASE: Diallyl phthalate(DAP)(UL 94V-0).
 PLUNGER: Polybutylene terephthalate (PBT) or Nylon (UL 94V-0).
 FRAME: Nylon 6/6 (UL 94HB), black standard.
 BUTTON & CAP: Nylon 6/6 or ABS, black standard.
 BUSHING: Brass, nickel plated.
 HOUSING: Stainless steel.
 TERMINAL SEAL: Epoxy.

If your preferred product configuration is not shown, please contact our sales representative for custom design.

HOW TO ORDER SYSTEM

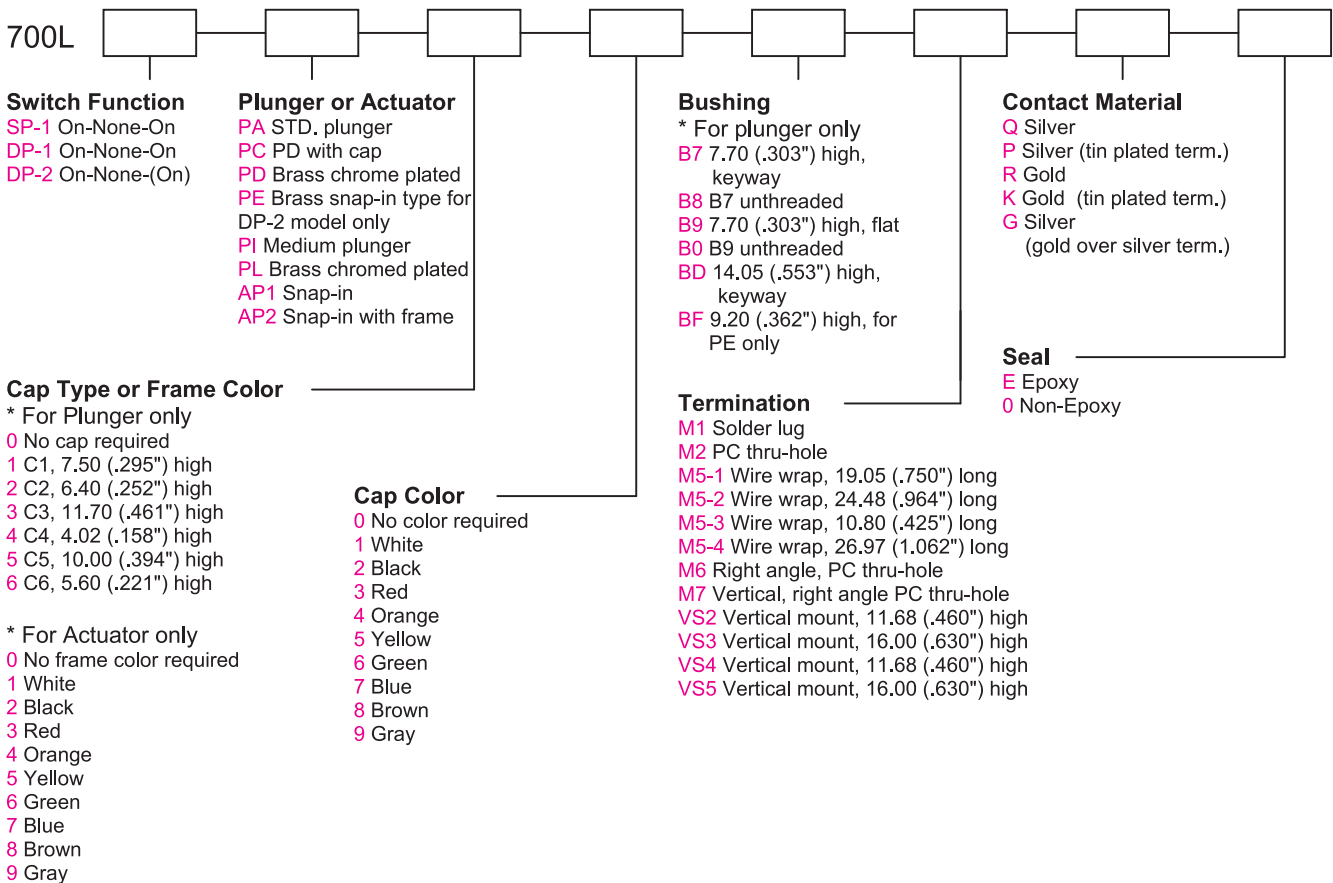

Specifications and Dimensions subject to change

Series 700L

Alternate Acting Pushbutton Switches

SPDT



Model No.	Switching Position		
	SP-1	ON	NONE
Term. Comm.	2-3	OPEN	2-1

Schematic

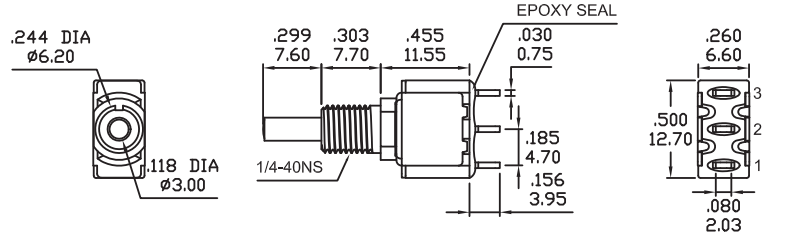

DPDT



Model No.	Switching Position		
	DP-1	ON	NONE
Term. Comm.	2-3,5-6	OPEN	2-1,5-4

Schematic

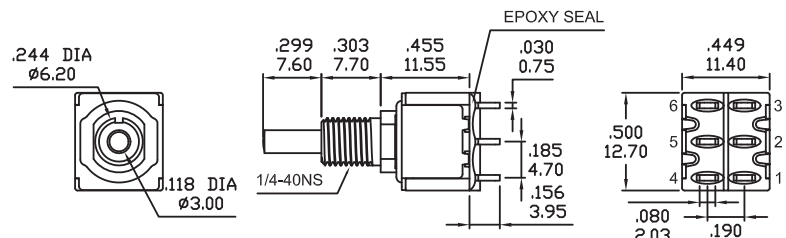
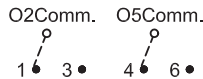

Model No.	Switching Position		
	DP-2	ON	NONE
Term. Comm.	2-3,5-6	OPEN	2-1,5-4

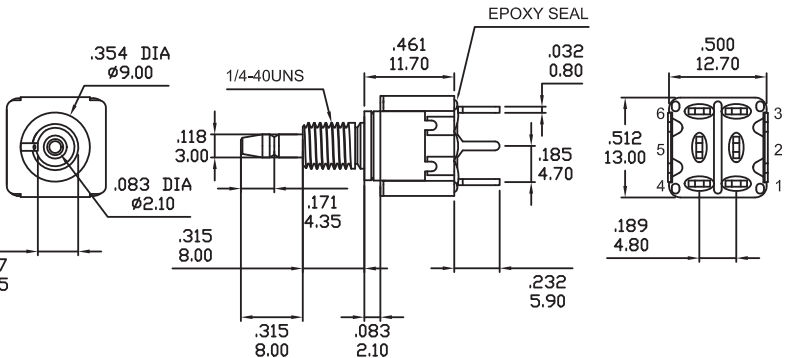

Part No. 700L-DP2-PE00BFM2xE, "x" Plating code

3PDT

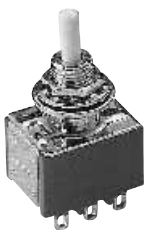

Model No.	Switching Position		
	3P-1	ON	NONE
Term. Comm.	2-3,5-6 8-9	OPEN	2-1,5-4 8-7

Schematic

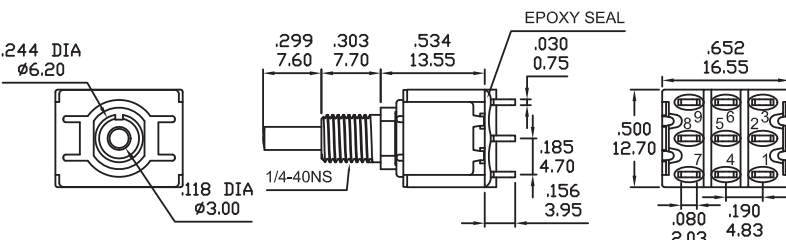

4PDT



Model No.	Switching Position		
	4P-1	ON	NONE
Term. Comm.	2-3,5-6 8-9 11-12	OPEN	2-1,5-4 8-7 11-10

Schematic

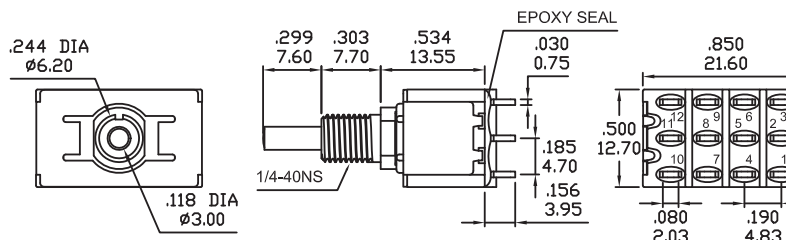
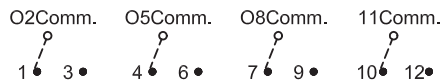

Series 700L

Alternate Acting Pushbutton Switches

ACTUATOR OPTIONS FOR SNAP-IN FRONT MOUNT

AP1

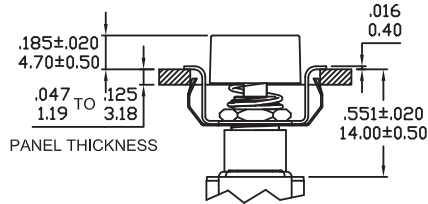
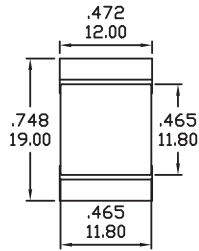

PANEL MOUNTING

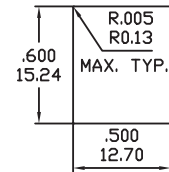

AP2 WITH FRAME

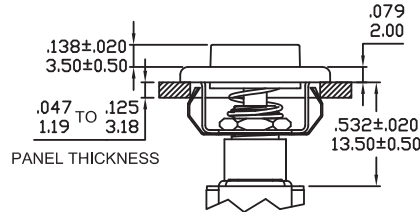
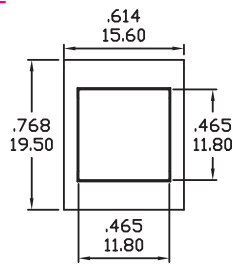

PANEL MOUNTING

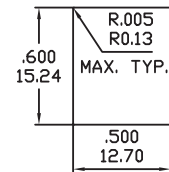

PLUNGER OPTIONS (SP-1 & DP-1 MODEL)

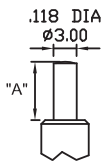

OPTION CODE	DIM "A"
PA	.299(7.60)
PI	.244(6.20)

PL

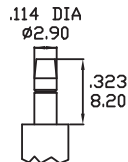

* Plunger material: Brass Nickel Plated

PC

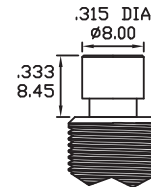

PD

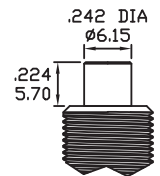

* Plunger material: Brass Chrome Plated
* PC,PD must configure with BD bushing

BUSHING OPTIONS (SP-1 & DP-1 MODEL)

B7 THD STD
B8 NON-THD

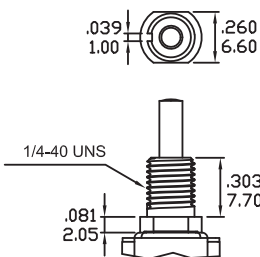

B9 THD STD
B0 NON-THD

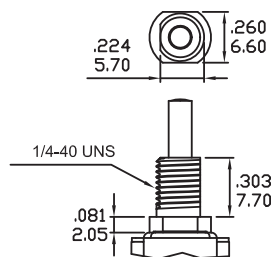

BD

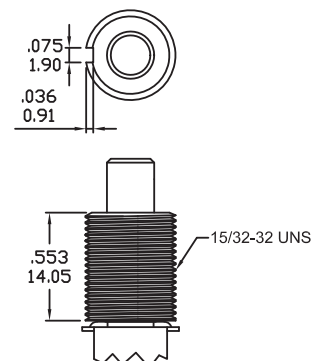

TERMINATION OPTIONS (SP-1 & DP-1 MODEL)

M1 STD. SOLDER LUG

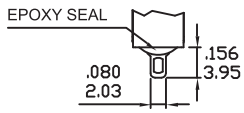

THK .030 (0.75)

M2 PC-THRU HOLE

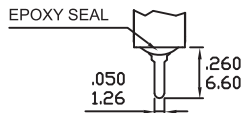

THK .030 (0.75)

M5 WIRE WRAP

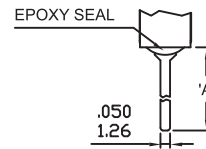

THK .030 (0.75)

OPTION CODE	DIM.'A'
M5-1	.750(19.05)
M5-2	.964(24.48)
M5-3	.425(10.80)
M5-4	1.062(26.97)

M6

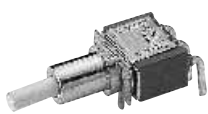

SPDT

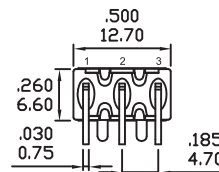
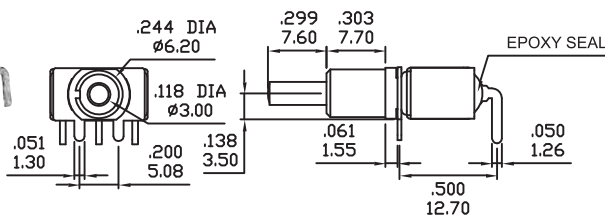

P.C.MOUNTING

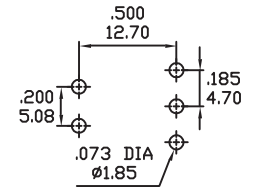

M6



DPDT

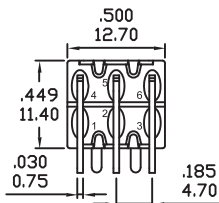
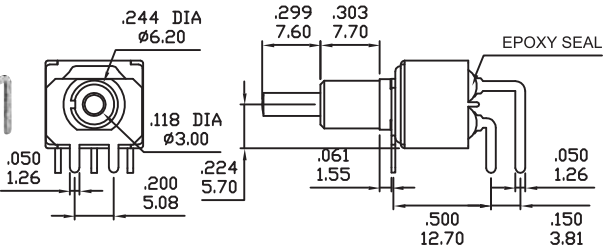

P.C.MOUNTING

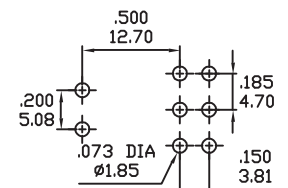

M7

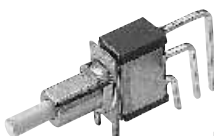

SPDT

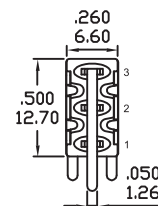
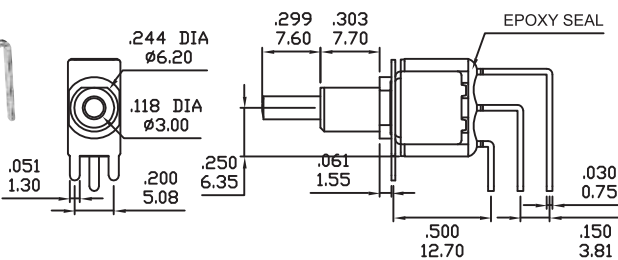

P.C.MOUNTING

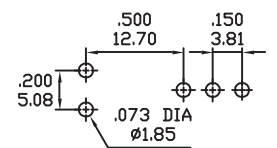

M7

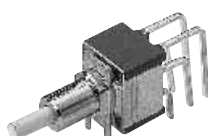

DPDT

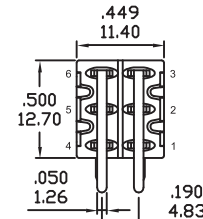
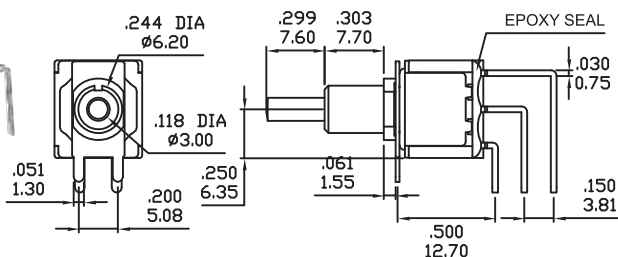

P.C.MOUNTING

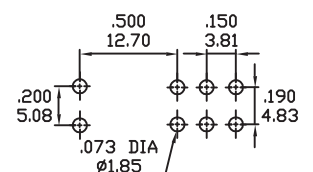

TERMINATION OPTIONS

M7

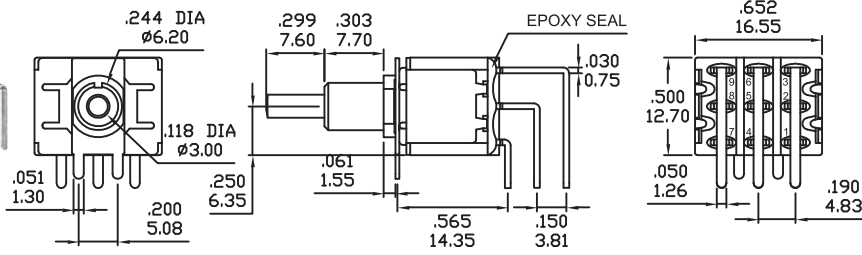
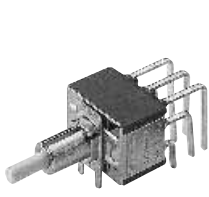

P.C.MOUNTING

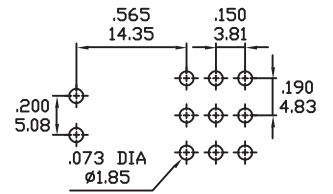

3PDT

M7

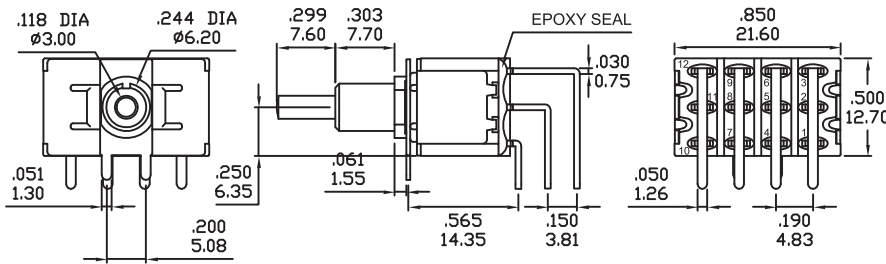

P.C.MOUNTING

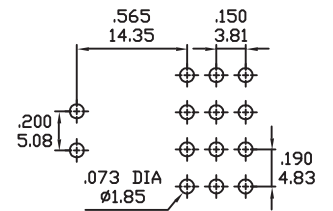

4PDT

VS2-VS3

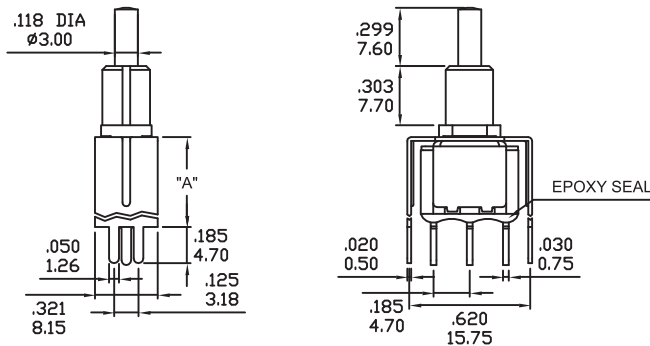

P.C.MOUNTING

OPTION CODE	DIM.'A'
VS2	.461 11.70
VS3	.630 16.00

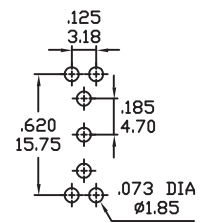

SPDT

VS2-VS3

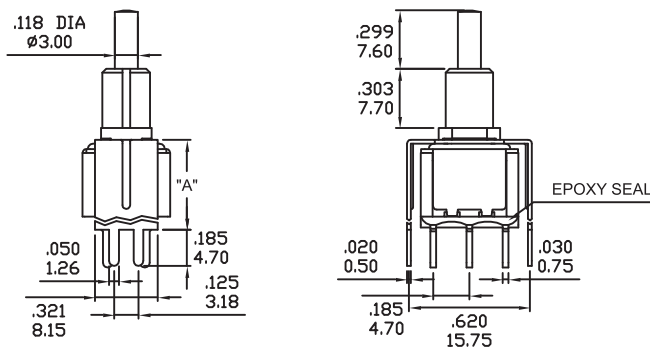
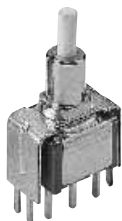

P.C.MOUNTING

OPTION CODE	DIM.'A'
VS2	.461 11.70
VS3	.630 16.00

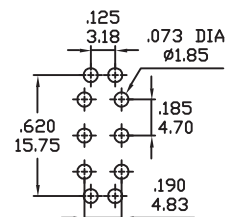

DPDT

VS4-VS5

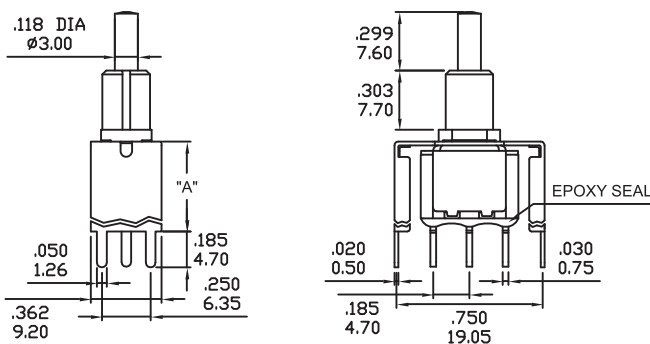

P.C.MOUNTING

OPTION CODE	DIM.'A'
VS4	.461 11.70
VS5	.630 16.00

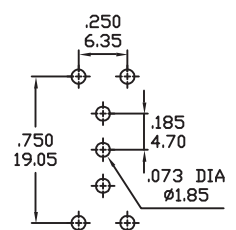

SPDT

Series 700L

Alternate Acting Pushbutton Switches

TERMINATION OPTIONS

VS4-VS5



DPDT

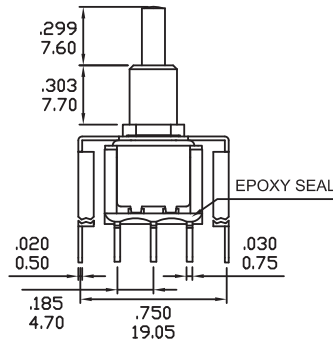
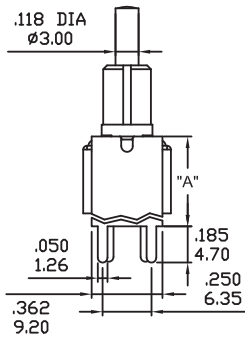

OPTION CODE	DIM.'A'
VS4	.461 11.70
VS5	.630 16.00

P.C.MOUNTING

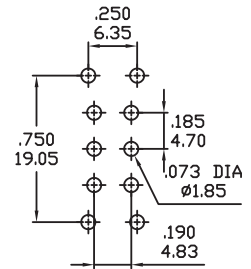

PLUNGER CAPS

C1

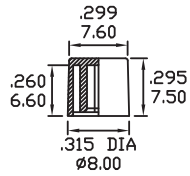

C2

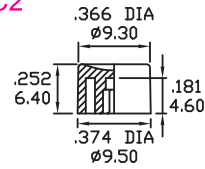

C3

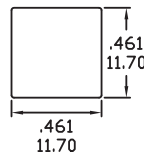

C4

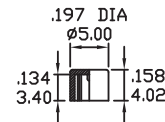

C5

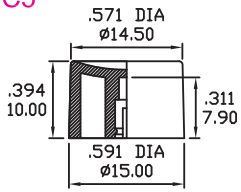

For PL plunger only

C6

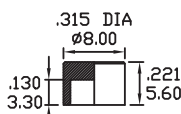

For PD plunger only

C7

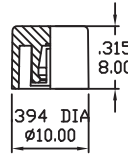



For PL plunger only

CAP AND FRAME COLORS	
1	White
2	Black
3	Red
4	Orange
5	Yellow
6	Green
7	Blue
8	Brown
9	Gray

MATERIAL: ABS for C1-C5.
MATERIAL: Brass for C6
Chrome or nickel plated.

CONTACT MATERIAL OPTIONS

Coding	Contact Material	Terminal Plating	Rating	Agency Approvals
Q	Silver ¹	Silver plated ⁶	6Amps @ 125VAC or 28VDC 3Amps @ 250VAC	
P		Tin plated ^{5,8}		
R	Gold ²	Gold plated ⁴	0.4VA max @ 20V max (AC or DC)	
K		Tin plated ^{5,7}		
G	Silver ¹	Gold over silver ³	6Amps @ 125VAC or 28VDC 3Amps @ 250VAC	

1. Movable Contact: Coin silver, silver plated.
2. Movable Contact: Copper alloy with gold plated over nickel plated.
3. Terminals: Silver plated with outer layer in gold plating.
4. Terminals: Copper alloy, with gold plated over nickel plated.
5. Outer Terminals: Copper alloy with pure tin plated.
6. Terminals: Copper alloy, silver plated.
7. Terminal Contact: Gold plated over nickel plated.
8. Terminal Contact: Palladium nickel alloy (or Silver) plated.

* P, K not available with M1 termination.